



Easy Light

BARCELONA  BYCARPYEN

*Closer
to Nature*

A new momentum

74 years old this year! Ten times the age of reason for Carpyen, the lighting manufacturer “Made In Barcelona”. Ten good reasons to open up to the world for this family company, ten good reasons to always be innovative and creative.

In 2018, the Carpyen manufacture direction has changed, a new impulse has been printed and new ideas are now expressed. In 2020, Carpyen launches CARPYEN EASY LIGHT, a collection of lamps with a responsible design, at an affordable price, without depart from the elegance that has made Carpyen an international reference since 1948.



EASY LIGHT

“We are from Barcelona, a city of light; We were born here and we grew up here. We continue to manufacture all our products on site, we are inspired by a lively, original, and cosmopolitan city, with a Mediterranean blue horizon, thousands of spaces to discover and thousands of stories to tell. We are proud to show the world that Carpyen “MADE IN BARCELONA” has a strong image and inexhaustible creative resources.”

Above all, it’s a human adventure. That is the beautiful and proud motto of the women and men at Carpyen.

A whole world of light to endlessly create and recreate in Carpyen’s workshop, in Spain.

from Barcelona

Natural trip

Exploring Spanish geography, let's take a new glance at the beauty of nature, from the Mediterranean islands, Balearic and Cantabrian, to the volcanoes of the Canary archipelago. Let's discover the natural phenomena caused by the effect of marine erosion and rain on limestone rock, giving way to cracks that connect the sea to the land in Asturias, to waterfalls that form a river at the mouth of the ocean in the Galician lands, to the wild beach of the Basque Country.

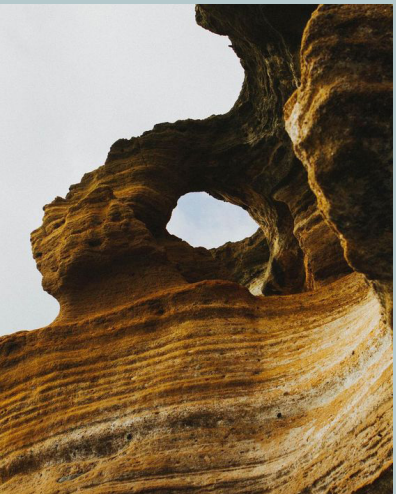

Landscapes of Spain



Bauxite



Olive

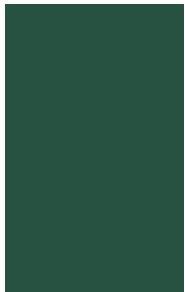

Picea

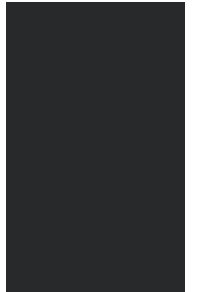
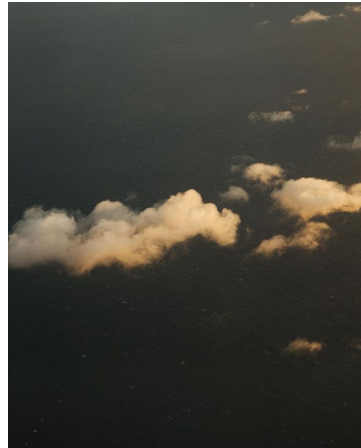

Graphite



Anthracite

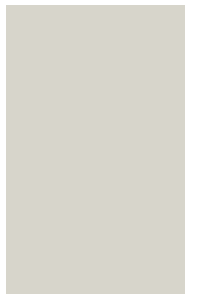

Chalk

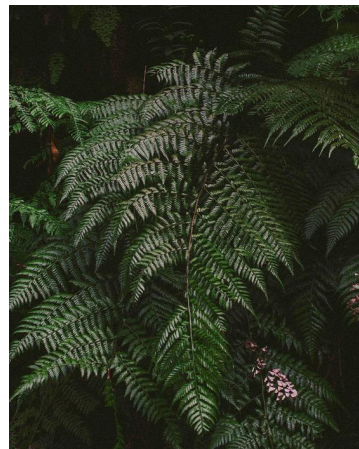
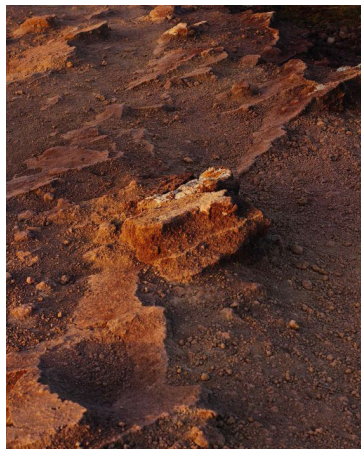

Serenity

Iberian coasts



Mimosa



Ocean



Aquamarine



Burgundy

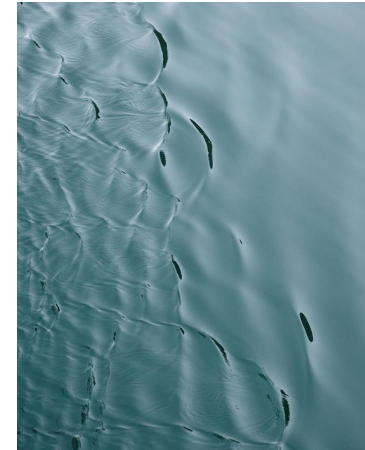
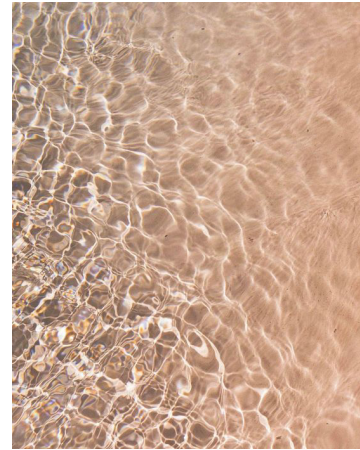
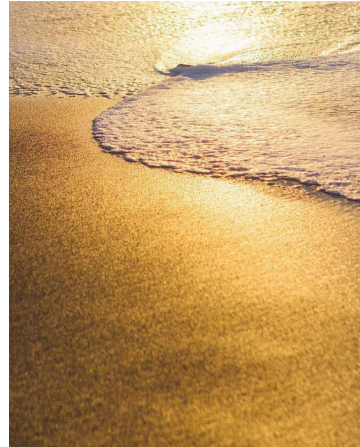

Peach

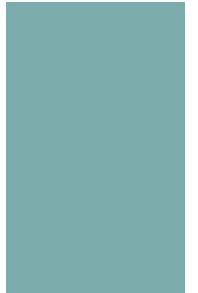

Crystalline

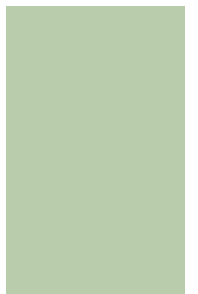

Aloe

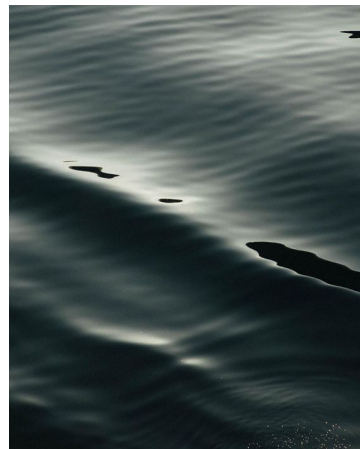
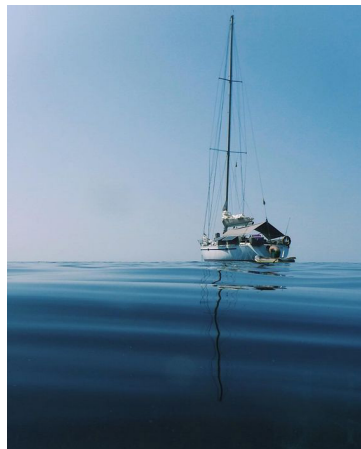

Optimism

Home is a feeling

Craftsmanship excellence and natural material define our new collection of suspension lamps, designed and manufactured in our own workshop in the heart of Barcelona.

The passion of our team combined with technical know-how contributes to uncompromising high quality and local production. The collection thus incorporates an environmental approach: ecological awareness and reduced carbon footprint. At the core of Carpyen vision, for over 74 years, responsible design invites itself in our homes at a reasonable cost.

Elegant pendant lights consist of a timeless design and essential shapes punctuated by refined pieces in wood or cork. Such materials bring us closer to nature, offering us a genuine feeling of well-being, comforting us in the days after this crisis. Like a refuge, our interior must be a real cocoon, to reassure and soothe us. Each light therefore plays with its unique composition to create a pleasant and comfortable atmosphere, to feel really good at home.





CLICK ON THE PRODUCT NAME TO GO TO ITS PAGE

Ons

Vedrá

Medas

Laga

Rofe

Roque

Fasnia

Olot

Tao

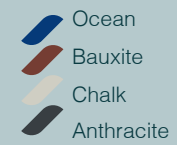
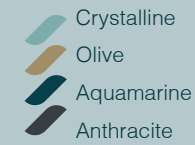
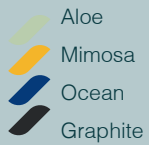
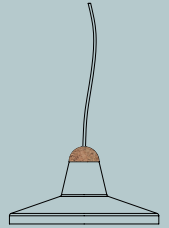
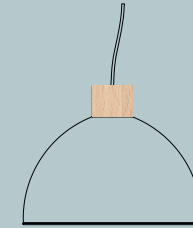
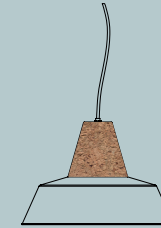
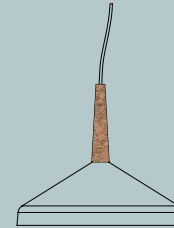
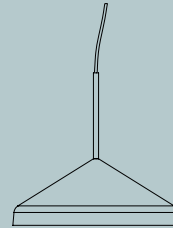
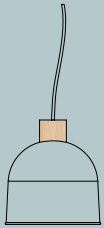

Ézaro

Famara

Pría

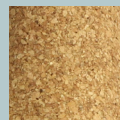

Cork



Beech

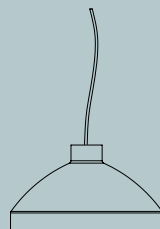
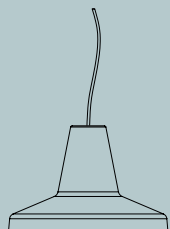
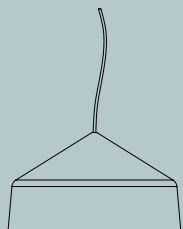

MATERIALS



Mimosa



Peach



Olive



Chalk



Ocean



Aloe



Bauxite



Anthracite



Aquamarine



Crystalline



Picea

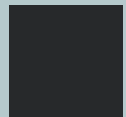

Graphite



Burgundy

COLOURS

For Contract projects choose your color *price quotation on request.



Ons

GALICIAN ISLANDS

In the Atlantic, the estuary of the Pontevedra river opens onto the Galician islands of Ons. Large coves and cliffs form its outline, discovering caves dug by the ocean, called "furnas".



Colours



Aloe

Mimosa

Ocean

Graphite

Materials

Beech and metal
Equipped with a cable of 2m / 78"
Bulb E27 LED max25W
not included

Vedrá

BALEARIC ISLET

Islet of the Balearic Islands, Es Vedrá is home to rich vegetation on a very small area, more than a hundred plant species, of which 12 are unique to this island.

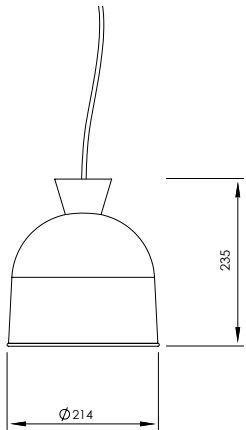

Colours

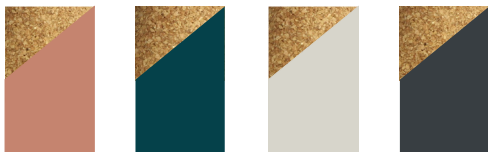

Peach

Aquamarine

Chalk

Graphite

Materials

Cork and metal
Equipped with a cable of 2m / 78"
Bulb E27 LED max25W
not included



MEDAS



Medas

CATALAN ISLAND

Herring gull or gray heron, sea birds love to fly over this great Mediterranean nature reserve, off the coast of Catalonia.

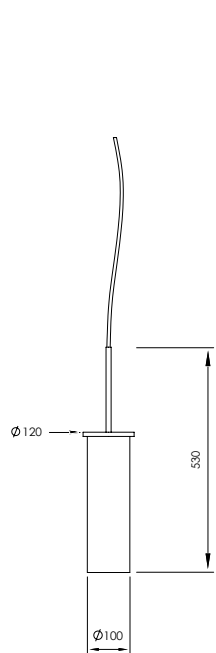

Colours



Picea

Chalk

Anthracite

Graphite

Materials

Beech and metal
Equipped with a cable of 2m / 78"
Bulb E27 LED max25W
not included





Laga

CANTABRIAN BEACH

Beach of the Cantabrian Sea, Laga consists of sand with perfectly golden grains, formed by the shells of marine invertebrates.

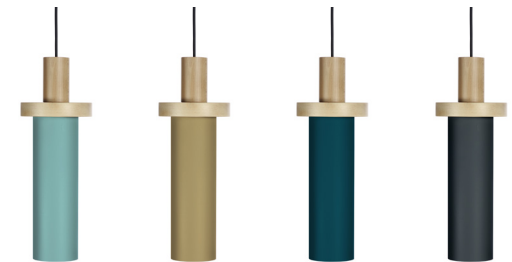
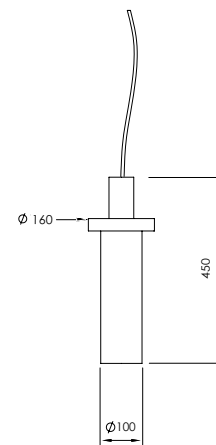

Colours



Crystalline Olive Aquamarine Anthracite

Materials

Beech and metal
Equipped with a cable of 2m / 78"
Bulb E27 LED max25W
not included



ROFE

Rofe

LANZAROTE SAND

Lanzarote volcanic sand, "rofe" means large rough grains, lava black colored, used as cultivated land for vines.



Colours



Peach Picea Chalk Graphite

Materials

Metal
Equipped with a cable of 2m / 78"
Bulb E27 LED max25W
not included





ROQUE

Roque

TENERIFE ROCK

In the heart of the island of Tenerife, Roque, a rock formation of volcanic origin, also called "Stone Tree" rises alongside the Teide.

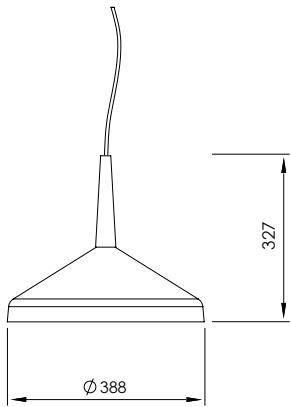

Colours



Aloe

Bauxite

Mimosa

Graphite

Materials

Cork and metal
Equipped with a cable of 2m / 78"
Bulb E27 LED max25W
not included



Fasnia

TENERIFE VOLCANO

Mount and volcano of Tenerife, Fasnia hides a pine forest at its summit where the trade wind blows.

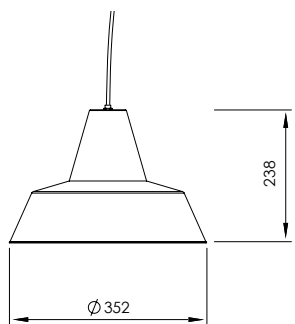

Colours

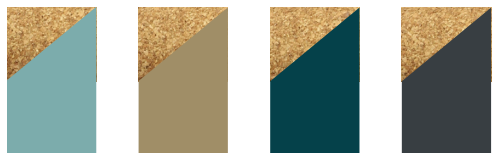

Crystalline Olive Aquamarine Anthracite

Materials

Cork and metal
Equipped with a cable of 2m / 78"
Bulb E27 LED max25W
not included



OLOT



Olot

CATALAN CITY

The beautiful city of Olot, located in the center of La Garrotxa, deploys its volcanic landscapes with clearly visible geological strata as well as a vast beech forest, called La Fageda.



Colours



Chalk Bauxite Ocean Anthracite

Materials

Beech and metal
Equipped with a cable of 2m / 78"
Bulb E27 LED max25W
not included



TAO





Tao

LANZAROTE VOLCANO

The earthquakes of 1824 formed the Tao volcano in Timanfaya Park. Still young, the volcanic landscape of Lanzarote is covered with lichens.



Colours



Materials

Cork and metal
Equipped with a cable of 2m / 78"
Bulb E27 LED max25W
not included

Outdoor trip



Ézaro

GALICIAN CASCADE

Cascade of Galicia, Ézaro precipitates the water of the Jallas river 40 meters lower, at its mouth with the sea, between the eroded walls of the canyon, at the foot of Mount Pindo.

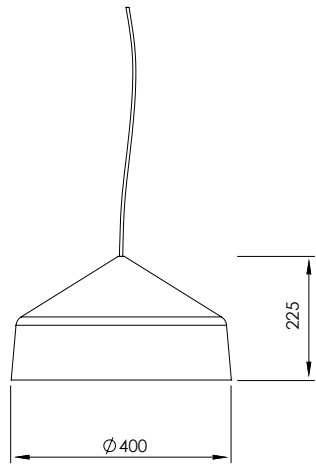

Colours



Burgundy

Ocean

Picea

Mimosa

Materials

Metal
Equipped with a cable of 7m / 275"
with power plug
Bulb E27 LED max13W not included
IP44





ÉZARO

Famara

CANARY BEACH

Both a mountain range and a beach, Famara is located at the limit of the Aeolian sand corridor of El Jable, on Lanzarote.

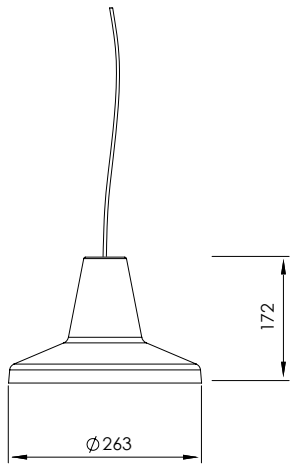

Colours



Burgundy

Picea

Mimosa

Ocean

Materials

Metal
Equipped with a cable of 7m / 275"
with power plug
Bulb E27 LED max13W not included
IP44





FAMARA & PRÍA

Pría

ASTURIAN GEYSER

In Asturias, the sea connects the land by “los Bufones de Pría”, cracks and chimneys of limestone dug by sea and rain. The waves infiltrate it, offering high casting of air and water, a true spectacle of nature.



Colours



Burgundy

Picea

Ocean

Mimosa

Materials

Metal
Equipped with a cable of 7m / 275”
with power plug
Bulb E27 LED max13W not included
IP44



PRÍA



PROYECTO ESPECIAL

SPECIAL PROJECT

PROJET SPÉCIAL

CREATE YOUR OWN NOVELTY





Easy Light

BARCELONA / BYCARPYEN

www.carpyn.com